

96

 Aluminiumjalousie 50

 Aluminium
horizontal blinds 50

 Store vénitien
aluminium 50

 Aluminium
jalożie 50

 Tenda veneziana
d'alluminio 50

 Žaluzja
alumiňowa 50

in der Lieferung enthalten • supplied in the set • fournis dans le coil • in de verpakking • incluso
• w zestawie:



x



1 x



2 x

nötige Geräte • necessary tools • les outils nécessaires • benodigdheden • attrezzatura necessaria
• niezbędne narzędzia:



x

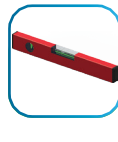

- Menge der Halter / Anzahl abhängig von der Breite
- The number of brackets / mounting profile fixing points depends on the width of the blind
- Nombre de supports / points de fixation dépend de la largeur du store
- Het aantal steunen / bevestigingspunten van het montageprofiel hangt af van de breedte van het product
- La quantità di sostegni/ punti di attacco dal profilo di montaggio dipende dalla larghezza del prodotto
- Ilość wieszaków / punktów mocowania w zależności od szerokości

≤850 mm

851 - 1500 mm

1501 - 2100 mm

2101 - 2700 mm

2701 - 3000 mm

3001 - 3300 mm

| | | | | | | |
|-----|---|---|---|---|---|---|
| X → | 2 | 3 | 4 | 5 | 6 | 7 |
|-----|---|---|---|---|---|---|

Montage / mounting / montaggio / montaż

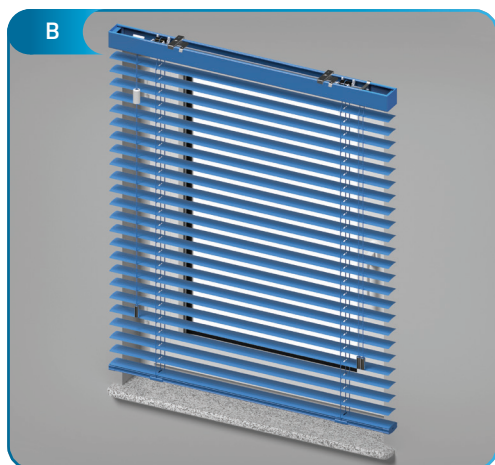
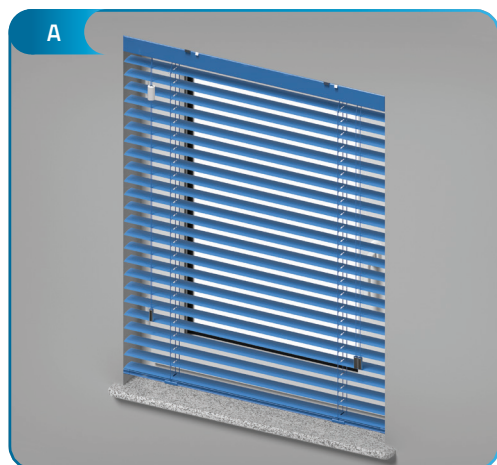

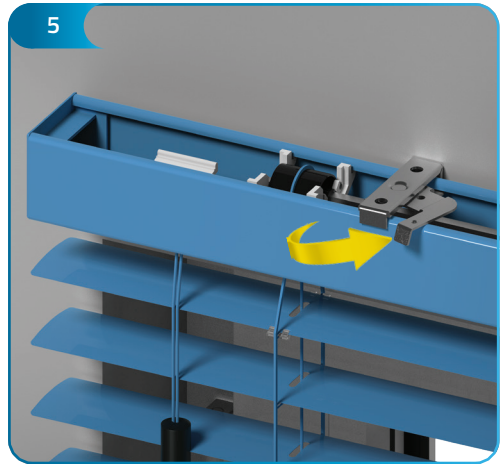
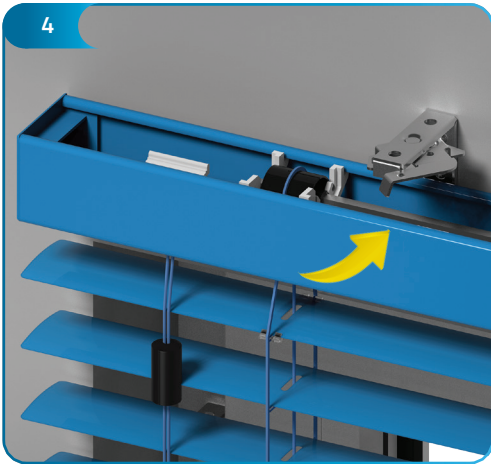
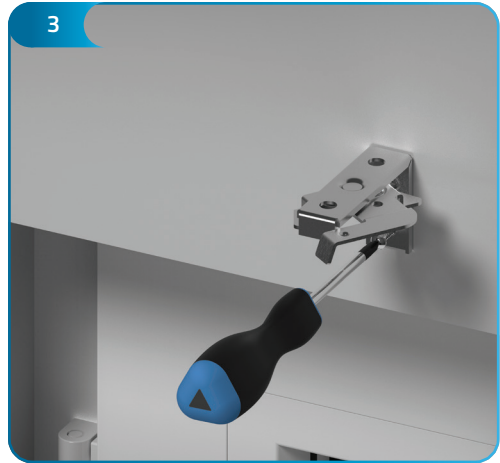
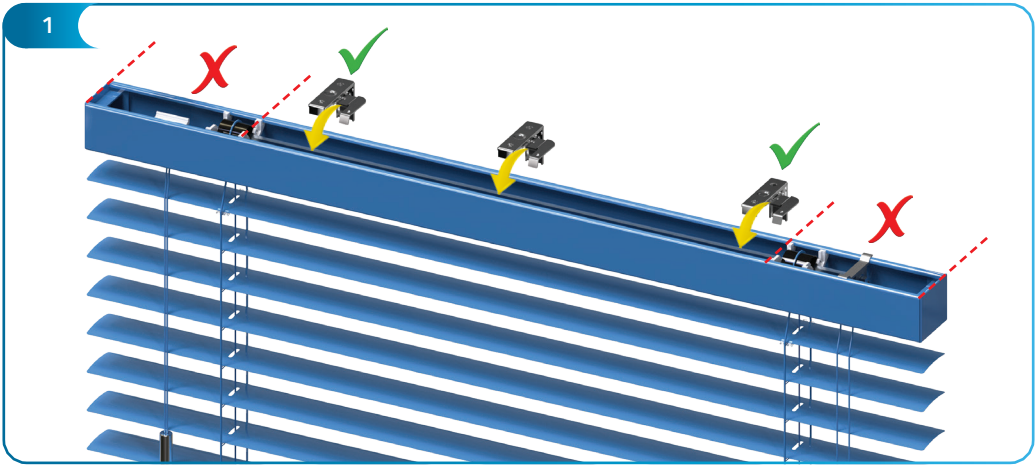

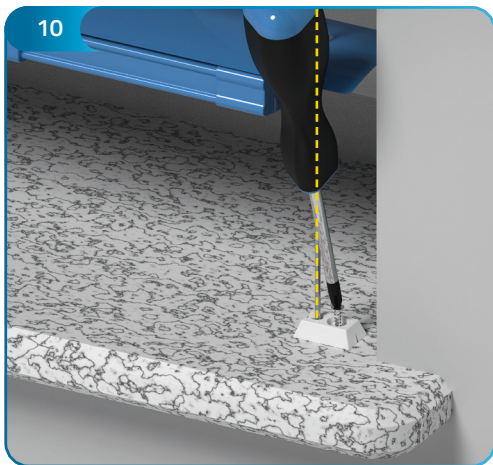
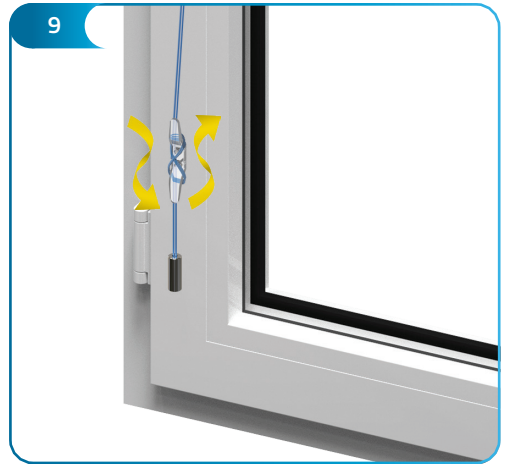
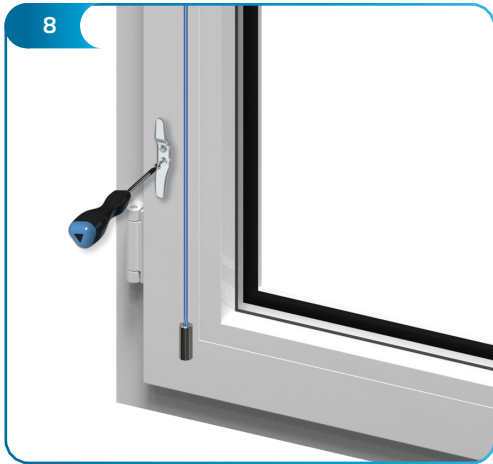
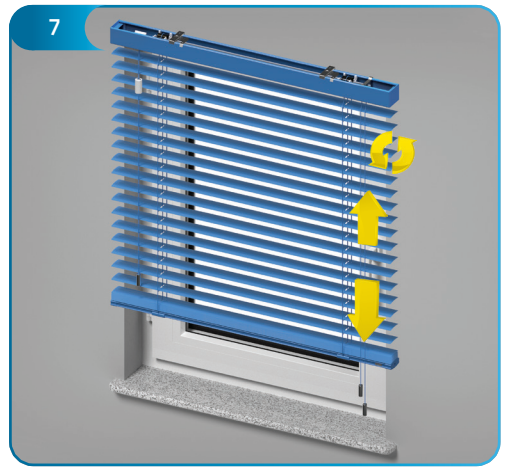
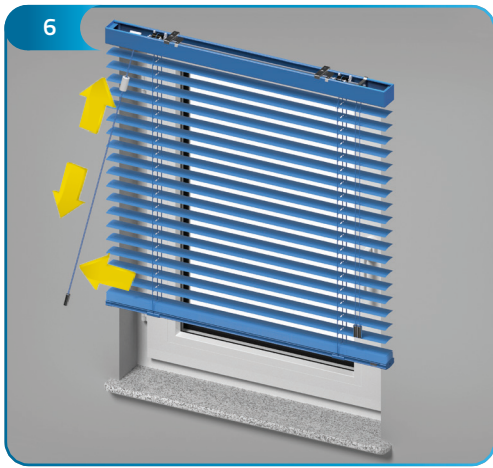

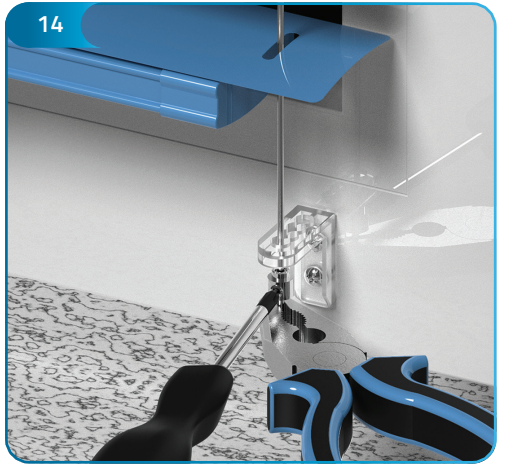
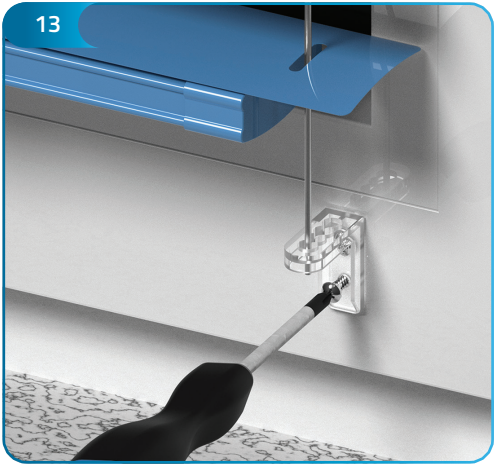
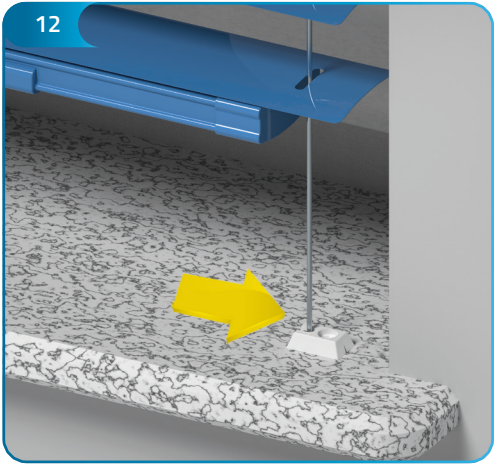

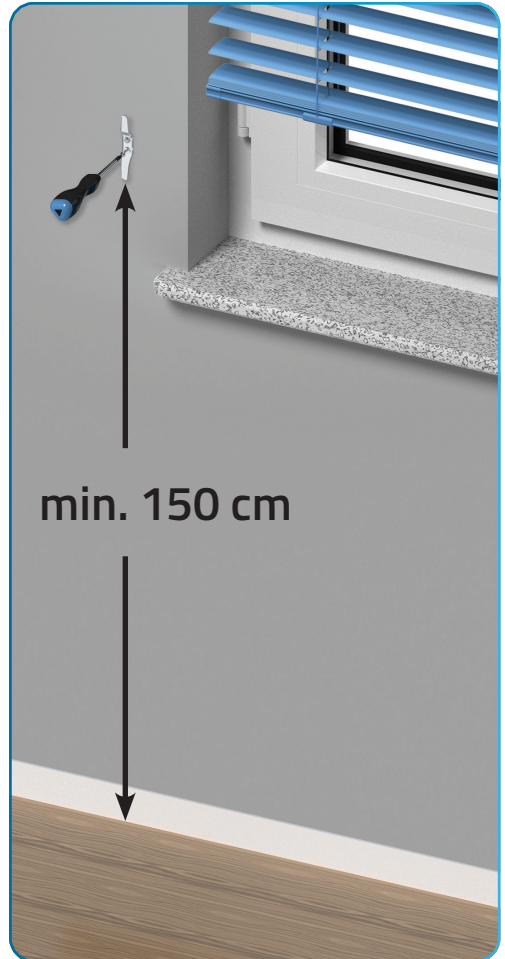

2 Schnürene • 2 cords • 2 cordes
2 koorden • 2 sznurki

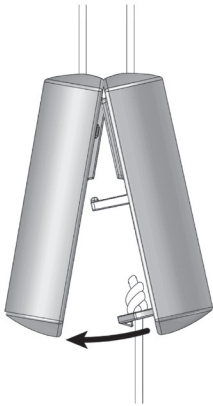
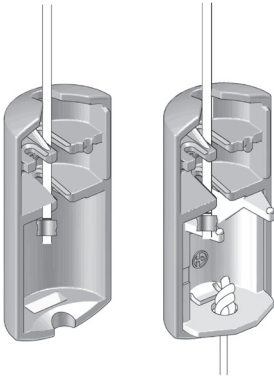

4 Schnürene • 4 cords • 4 cordes
4 koorden • 4 sznurki

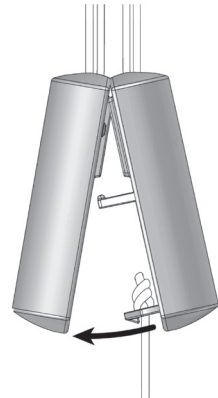
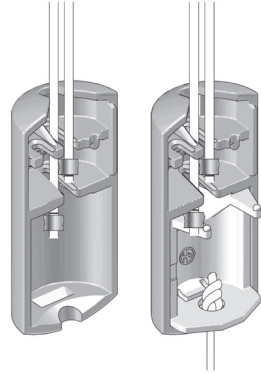

DE WARNUNG

Kleine Kinder können sich in den Schlingen von Schnüren und Ketten zur Betätigung von Fensterdekorationen verwickeln und strangulieren. Schnüre und Ketten sind daher außerhalb der Reichweite von Kindern zu halten, um Unfälle zu vermeiden. Betten, Kinderbetten und Möbel sind entfernt von Schnüren und Ketten für Fensterdekorationen aufzustellen. Um das Risiko eines Unfalls zu reduzieren, empfehlen wir die Verwendung der mitgelieferten Kindersicherung, die zu Standardausrüstung unserer hergestellten Produkte gehören.

EN WARNING

Young children can be strangled by loops in pull cords, chains, tapes, and inner cords that operate the product. They may become wrapped around children's necks which may result in strangulation or permanent disability. Keep cords out of the reach of young children. Move beds, cots and furniture away from window covering cords. Do not tie cords together. Make sure cords do not twist and create a loop. To eliminate the risk of accidents we recommend using safety features, which are standard equipment of all sun-protection systems made in our company.

FR Le AVERTISSEMENT

Dans certaines circonstances, les enfants peuvent être pris dans une boucle de ficelle, carters de chaîne ou d'une fenêtre. Par conséquent, il y a un grand risque que mentionné ci-dessus éléments peuvent enrouler autour du cou d'un enfant, entraînant une suffocation ou d'invalidité permanente. Afin d'éviter que les enfants emmêlement les contrôles, les chaînes et les cordons doivent être placés dans la portée des mineurs, entre autres, loin des chaises et des lits. Ne pas attacher les cordes. Il faut vérifier que les cordons ne se croisent pas et ne forment pas une boucle. Pour réduire le risque d'accident, nous vous recommandons les caractéristiques de sécurité préférées, qui sont l'équipement standard fabriqué par nos pare-fenêtre.

NL WAARSCHUWING

Jonge kinderen kunnen verstrikt raken in de lus van de trekkoorden, kettingen, banden en koorden waarmee de raambekleding bediend wordt. Ook kunnen ze koorden om hun hals wikkelen. Houd, om wurging en verstikking te voorkomen, de koorden buiten het bereik van jonge kinderen. Plaats bedden, wiegen en ander meubilair uit de buurt van de koorden van raambekleding. Knoop de koorden niet aan elkaar. Zorg dat de koorden niet verstrengeld raken of een lus vormen. Installeer en gebruik de bijgeleverde onderdelen voor kindveiligheid overeenkomstig de installatie-instructies om het risico op verstikking en verstrengeling te verkleinen.

IT AVVERTIMENTO

I bambini piccoli possono essere intrappolati nell'occhiello dei cordoncini, catene, gomme e corde con cui le coperture per finestre vengono regolate. Si possono avvolgere anche corde sul collo. Tieni le corde lontano da bambini piccoli, per evitare strangolamento e soffocamento. Metti lontano letti, culle e altri mobili dalle corde delle coperture per finestre. Non legare le corde. Assicurarsi che le corde non vengono intrecciate e che formano un cappio. Installare e utilizzare i componenti di sicurezza per bambini forniti in conformità con le istruzioni di installazione per ridurre il rischio di soffocamento e intrappolamento.

PL OSTRZEŻENIE

W pewnych okolicznościach dzieci mogą zaplątać się w pętlę sznurka lub łańcuszka osłon okiennych. W związku z powyższym, istnieje duże zagrożenie, że ww. elementy mogą owinąć się wokół szyi dziecka, co grozi uduszeniem lub trwałym kalectwem. W celu uniknięcia zaplątania dzieci w elementy sterowania, łańcuszki oraz sznurki należy umieszczać w miejscu niedostępnym dla małych dzieci m.in. z dala od foteli i łóżeczek dziecięcych. Nie należy wiązać sznurków. Winno się sprawdzić, czy sznurki nie krzyżują się i nie tworzą pętli. Aby zmniejszyć ryzyko wypadku, zalecamy korzystnie z elementów zabezpieczających, które stanowią standardowe wyposażenie produkowanych przez nas osłon okiennych.

