

GEWEBE

# VERTIKALJALOUSIEN

COLORS | THERMO | DARK | SPECIALS



**GROUP**  
**SOLARMATIC®**  
IHR SONDERBAU-EXPERTE

# VERTIKALJALOUSIEN

Schientypen | Gewebe

## Softline Typ 1

- » Bedienung über Schnur / Kette
- » Lamellenhaken leicht austauschbar
- » Option: **federnder Stahllamellenhaken**
- » Edelstahl-Abstandshalter
- » max. Breite 7 m
- » auch in eckiger Ausführung: **Project Typ 2**

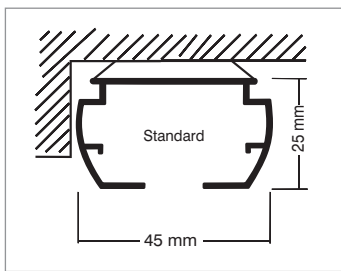

## Vario Typ 3

- » Bedienung über Schnur / Kette, optional: Kette, IQ-Motor 230 V
- » **sämtl. Typen und Bedienarten möglich**
- » Edelstahl-Abstandshalter
- » max. Breite 7 m
- » Paket verschiebbar
- » Option: **Deckeneinbauprofil mit Clip**

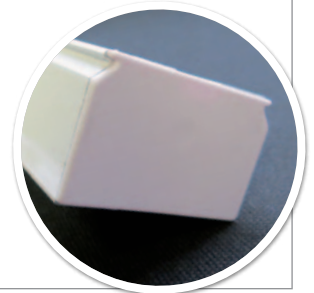
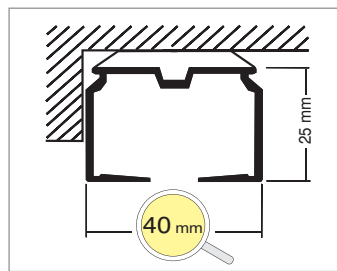

## Paketaufteilung

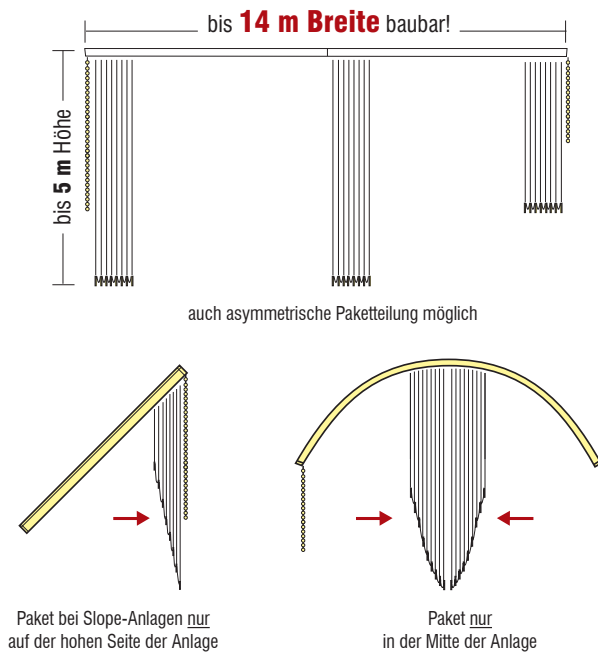

## Deckeneinbauprofil

- » Einbauprofil mit Halterbefestigung für abgehängte Decken
- » einsetzbar für Schienen: **Project Typ 2, Vario Typ 3**

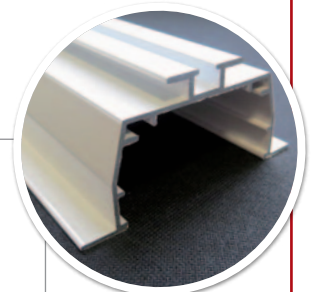
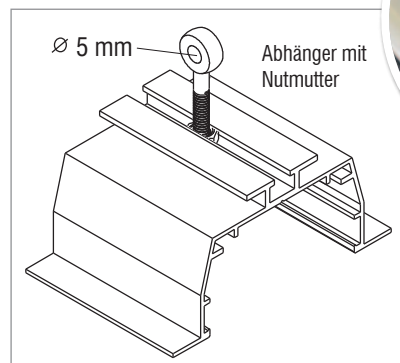

## KOLLEKTION COLORS - Colors I - IV

32 FARBEN

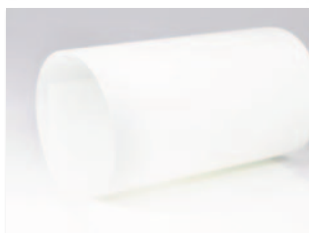

PG 1

5315

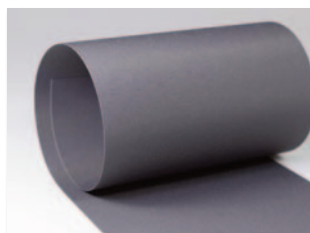

PG 1

5309



PG 1

5306





**KOLLEKTION: COLORS - Home**

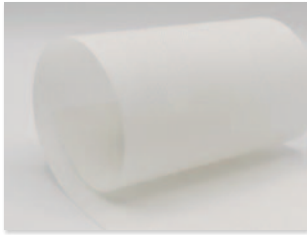

PG 3

7064

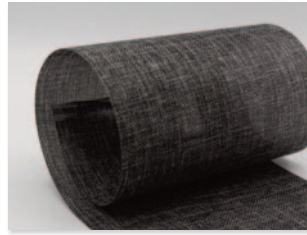

PG 3

7061

**Acoustics**

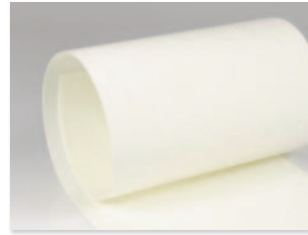

PG 3

7001

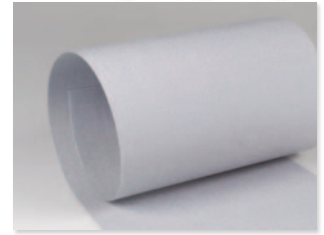

PG 3

7004



**KOLLEKTION: THERMO - Screens I**

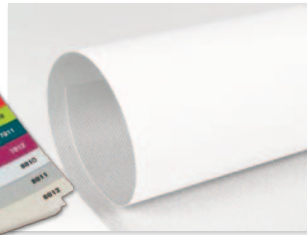

PG 4

8030



PG 5

9400



**KOLLEKTION: THERMO - Pearl II**



PG 3

7020

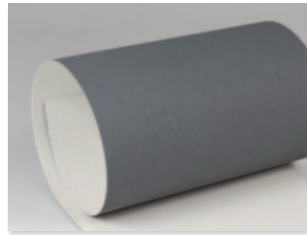

PG 3

7026

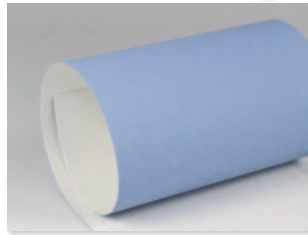

PG 3

7027



**KOLLEKTION DARK - Clean**



PG 2

6020

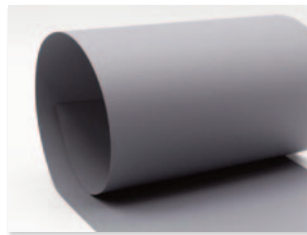

PG 2

6023

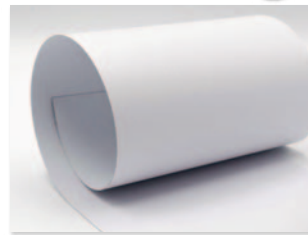

PG 3

7015

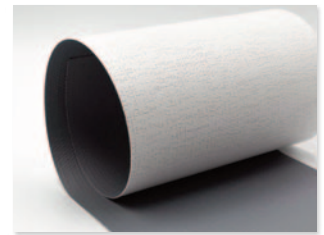

PG 5

9010



**SPECIALS: Fireproof nicht brennbar A2**



PG 3

7071

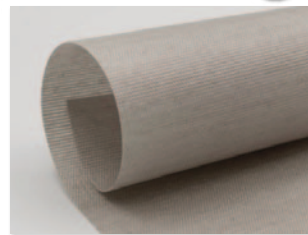

PG 3

7072



**JETZT ENTDECKEN**  
auch als  
**Fotolamelle!**

# VERTIKALJALOUSIEN

Aufmaß

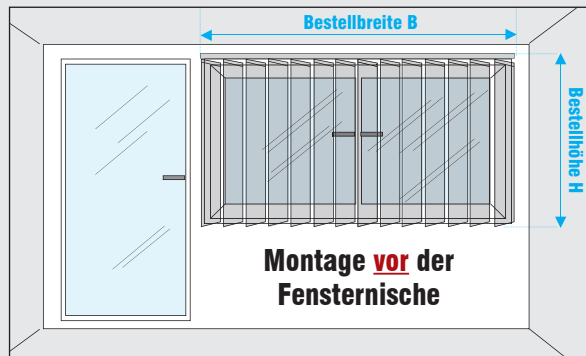

Bestellbreite (B) = Nischenbreite + gewünschter Überstand  
 Bestellhöhe (H) = Nischenhöhe + gewünschter Überstand  
 Decken- und Wandmontage möglich.

**Bitte beachten Sie:**

Paketbreite, Fensterbank, Fenstergriffe, überstehende Beschläge, Heizkörper, empfohlene Bodenfreiheit 2 cm

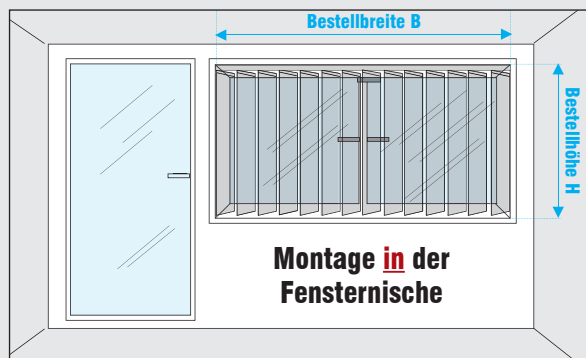

**Wandmontage:**

Bestellbreite (B) = Nischenbreite - 10 mm  
 Bestellhöhe (H) = Nischenhöhe - 40 mm

**Wandmontage mit Nischenträger:**

Bestellbreite (B) = Nischenbreite - 20 mm  
 Bestellhöhe (H) = Nischenhöhe - 40 mm  
 Maße an mehreren Stellen kontrollieren

**Deckenmontage:**

Bestellbreite (B) = Nischenbreite - 10 mm  
 Bestellhöhe (H) = Nischenhöhe - 20 mm

**Bitte beachten Sie:**

Paketbreite, Fenstergriffe, überstehende Beschläge, Heizkörper, empfohlene Bodenfreiheit 2 cm

## SONDERFORMEN

